

marantz®

Model PM-11S3 Owner's Manual

Integrated Amplifier

SAFETY PRECAUTIONS



CAUTION
RISK OF ELECTRIC SHOCK
DO NOT OPEN



CAUTION:
TO REDUCE THE RISK OF ELECTRIC SHOCK, DO NOT REMOVE COVER (OR BACK). NO USER-SERVICEABLE PARTS INSIDE. REFER SERVICING TO QUALIFIED SERVICE PERSONNEL.



The lightning flash with arrowhead symbol, within an equilateral triangle, is intended to alert the user to the presence of uninsulated "dangerous voltage" within the product's enclosure that may be of sufficient magnitude to constitute a risk of electric shock to persons.



The exclamation point within an equilateral triangle is intended to alert the user to the presence of important operating and maintenance (servicing) instructions in the literature accompanying the appliance.

WARNING:
TO REDUCE THE RISK OF FIRE OR ELECTRIC SHOCK, DO NOT EXPOSE THIS APPLIANCE TO RAIN OR MOISTURE.



Hot
surface
mark

CAUTION:
HOT SURFACE. DO NOT TOUCH.

The top surface over the internal heat sink may become hot when operating this product continuously. Do not touch hot areas, especially around the "Hot surface mark" and the top panel.

PRECAUTION:
SURFACE CHAUDE. NE PAS TOUCHER.

La surface supérieure du dissipateur de chaleur peut devenir chaude si vous utilisez ce produit en continu. Ne touchez pas les zones chaudes, tout particulièrement vers l'inscription "Hot surface mark" et le panneau supérieur.

PRECAUCIÓN:
SUPERFICIE CALIENTE. NO TOCAR.

La superficie superior sobre el disipador de calor interno podría llegar a calentarse al operar este producto de forma continua.

No toque las áreas calientes, especialmente las situadas alrededor de la "Hot surface mark" y del panel superior.

IMPOTANT SAFETY INSTRUCTIONS

1. Read these instructions.
2. Keep these instructions.
3. Heed all warnings.
4. Follow all instructions.
5. Do not use this apparatus near water.
6. Clean only with dry cloth.
7. Do not block any ventilation openings. Install in accordance with the manufacturer's instructions.
8. Do not install near any heat sources such as radiators, heat registers, stoves, or other apparatus (including amplifiers) that produce heat.
9. Do not defeat the safety purpose of the polarized or grounding-type plug. A polarized plug has two blades with one wider than the other. A grounding type plug has two blades and a third grounding prong. The wide blade or the third prong are provided for your safety. If the provided plug does not fit into your outlet, consult an electrician for replacement of the obsolete outlet.
10. Protect the power cord from being walked on or pinched particularly at plugs, convenience receptacles, and the point where they exit from the apparatus.
11. Only use attachments/accessories specified by the manufacturer.
12. Use only with the cart, stand, tripod, bracket, or table specified by the manufacturer, or sold with the apparatus. When a cart is used, use caution when moving the cart/apparatus combination to avoid injury from tip-over.
13. Unplug this apparatus during lightning storms or when unused for long periods of time.
14. Refer all servicing to qualified service personnel. Servicing is required when the apparatus has been damaged in any way, such as power-supply cord or plug is damaged, liquid has been spilled or objects have fallen into the apparatus, the apparatus has been exposed to rain or moisture, does not operate normally, or has been dropped.
15. Batteries shall not be exposed to excessive heat such as sunshine, fire or the like.



FCC INFORMATION (For US customers)

1. PRODUCT

This product complies with Part 15 of the FCC Rules. Operation is subject to the following two conditions: (1) this product may not cause harmful interference, and (2) this product must accept any interference received, including interference that may cause undesired operation.

2. IMPORTANT NOTICE: DO NOT MODIFY THIS PRODUCT

This product, when installed as indicated in the instructions contained in this manual, meets FCC requirements. Modification not expressly approved by Marantz may void your authority, granted by the FCC, to use the product.

3. NOTE

This product has been tested and found to comply with the limits for a Class B digital device, pursuant to Part 15 of the FCC Rules. These limits are designed to provide reasonable protection against harmful interference in a residential installation.

This product generates, uses and can radiate radio frequency energy and, if not installed and used in accordance with the instructions, may cause harmful interference to radio communications. However, there is no guarantee that interference will not occur in a particular installation. If this product does cause harmful interference to radio or television reception, which can be determined by turning the product OFF and ON, the user is encouraged to try to correct the interference by one or more of the following measures:

- Reorient or relocate the receiving antenna.
- Increase the separation between the equipment and receiver.
- Connect the product into an outlet on a circuit different from that to which the receiver is connected.
- Consult the local retailer authorized to distribute this type of product or an experienced radio/TV technician for help.

For Canadian customers:

This Class B digital apparatus complies with Canadian ICES-003. Cet appareil numérique de la classe B est conforme à la norme NMB-003 du Canada.

CAUTION:

To completely disconnect this product from the mains, disconnect the plug from the wall socket outlet.

The mains plug is used to completely interrupt the power supply to the unit and must be within easy access by the user.

PRECAUTION:

Pour déconnecter complètement ce produit du courant secteur, débranchez la prise de la prise murale.

La prise secteur est utilisée pour couper complètement l'alimentation de l'appareil et l'utilisateur doit pouvoir y accéder facilement.

PRECAUCIÓN:

Para desconectar completamente este producto de la alimentación eléctrica, desconecte el enchufe del enchufe de la pared.

El enchufe de la alimentación eléctrica se utiliza para interrumpir por completo el suministro de alimentación eléctrica a la unidad y debe de encontrarse en un lugar al que el usuario tenga fácil acceso.

□ NOTES ON USE / OBSERVATIONS RELATIVES A L'UTILISATION / NOTAS SOBRE EL USO

WARNINGS	AVERTISSEMENTS	ADVERTENCIAS
<ul style="list-style-type: none"> • Avoid high temperatures. Allow for sufficient heat dispersion when installed in a rack. • Handle the power cord carefully. Hold the plug when unplugging the cord. • Keep the unit free from moisture, water, and dust. • Unplug the power cord when not using the unit for long periods of time. • Do not obstruct the ventilation holes. • Do not let foreign objects into the unit. • Do not let insecticides, benzene, and thinner come in contact with the unit. • Never disassemble or modify the unit in any way. • Ventilation should not be impeded by covering the ventilation openings with items, such as newspapers, tablecloths or curtains. • Naked flame sources such as lighted candles should not be placed on the unit. • Observe and follow local regulations regarding battery disposal. • Do not expose the unit to dripping or splashing fluids. • Do not place objects filled with liquids, such as vases, on the unit. • Do not handle the mains cord with wet hands. • When the switch is in the OFF position, the equipment is not completely switched off from MAINS. • The equipment shall be installed near the power supply so that the power supply is easily accessible. • Do not keep the battery in a place exposed to direct sunlight or in places with extremely high temperatures, such as near a heater. 	<ul style="list-style-type: none"> • Éviter des températures élevées. Tenir compte d'une dispersion de chaleur suffisante lors de l'installation sur une étagère. • Manipuler le cordon d'alimentation avec précaution. Tenir la prise lors du débranchement du cordon. • Protéger l'appareil contre l'humidité, l'eau et la poussière. • Débrancher le cordon d'alimentation lorsque l'appareil n'est pas utilisé pendant de longues périodes. • Ne pas obstruer les trous d'aération. • Ne pas laisser des objets étrangers dans l'appareil. • Ne pas mettre en contact des insecticides, du benzène et un diluant avec l'appareil. • Ne jamais démonter ou modifier l'appareil d'une manière ou d'une autre. • Ne pas recouvrir les orifices de ventilation avec des objets tels que des journaux, nappes ou rideaux. Cela entraverait la ventilation. • Ne jamais placer de flamme nue sur l'appareil, notamment des bougies allumées. • Veillez à respecter les lois en vigueur lorsque vous jetez les piles usagées. • L'appareil ne doit pas être exposé à l'eau ou à l'humidité. • Ne pas poser d'objet contenant du liquide, par exemple un vase, sur l'appareil. • Ne pas manipuler le cordon d'alimentation avec les mains mouillées. • Lorsque l'interrupteur est sur la position OFF, l'appareil n'est pas complètement déconnecté du SECTEUR (MAINS). • L'appareil sera installé près de la source d'alimentation, de sorte que cette dernière soit facilement accessible. • Ne placez pas la pile dans un endroit exposé à la lumière directe du soleil ou dans des endroits présentant des températures extrêmement élevées, par exemple près d'un radiateur. 	<ul style="list-style-type: none"> • Evite altas temperaturas. Permita la suficiente dispersión del calor cuando está instalado en la consola. • Maneje el cordón de energía con cuidado. Sostenga el enchufe cuando desconecte el cordón de energía. • Mantenga el equipo libre de humedad, agua y polvo. • Desconecte el cordón de energía cuando no utilice el equipo por mucho tiempo. • No obstruya los orificios de ventilación. • No deje objetos extraños dentro del equipo. • No permita el contacto de insecticidas, gasolina y diluyentes con el equipo. • Nunca desarme o modifique el equipo de ninguna manera. • La ventilación no debe quedar obstruida por haberse cubierto las aperturas con objetos como periódicos, manteles o cortinas. • No deberán colocarse sobre el aparato fuentes inflamables sin protección, como velas encendidas. • A la hora de deshacerse de las pilas, respete la normativa para el cuidado del medio ambiente. • No exponer el aparato al goteo o salpicaduras cuando se utilice. • No colocar sobre el aparato objetos llenos de líquido, como jarras. • No maneje el cable de alimentación con las manos mojadas. • Cuando el interruptor está en la posición OFF, el equipo no está completamente desconectado de la alimentación MAINS. • El equipo se instalará cerca de la fuente de alimentación de manera que resulte fácil acceder a ella. • No coloque las pilas en un lugar expuesto a la luz directa del sol o donde la temperatura sea extremadamente alta, como cerca de una calefacción.

□ Cautions on installation Précautions d'installation Emplazamiento de la instalación

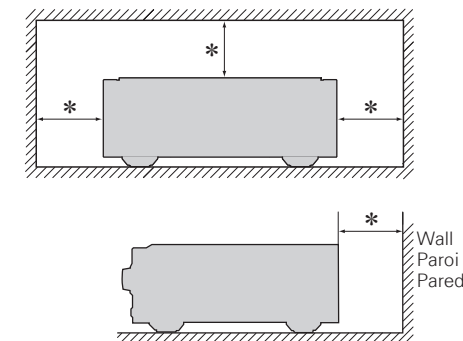

* For proper heat dispersal, do not install this unit in a confined space, such as a bookcase or similar enclosure.

- More than 12 in. (0.3 m) is recommended.
- Do not place any other equipment on this unit.

* Pour permettre la dissipation de chaleur requise, n'installez pas cette unité dans un espace confiné tel qu'une bibliothèque ou un endroit similaire.

- Une distance de plus de 12 po (0,3 m) est recommandée.
- Ne placez aucun matériel sur cet appareil.

* Para la dispersión del calor adecuadamente, no instale este equipo en un lugar confinado tal como una librería o unidad similar.

- Se recomienda dejar más de 12 pulg. (0,3 m) alrededor.
- No coloque ningún otro equipo sobre la unidad.

PROPOSITION 65 WARNING (California only)

This product contains a chemical known to the State of California to cause cancer and birth defects or other reproductive harm.
For more information go to www.p65warnings.ca.gov

Getting started

Thank you for purchasing this marantz product. To ensure proper operation, please read this owner's manual carefully before using the product.

After reading the manual, be sure to keep it for future reference.

Contents

Getting started	1	Advanced connections	14
Accessories	1	F.C.B.S. connection	14
About this manual	1	Preparation for F.C.B.S. connection.....	14
Cautions on handling	2	Stereo complete bi-amp connection.....	16
About the remote control	2	Connection for 5.1 Multi-channel Playback.....	17
Inserting the batteries.....	2	Connecting P.DIRECT IN connectors	19
Operating range of the remote control unit.....	2	Connecting pre out connectors	19
Features	3	Connecting the remote control connectors	20
Part names and functions	4	Advanced operations	20
Front panel.....	4	Setting Auto standby mode	20
Rear panel.....	4	Explanation terms	21
Remote control.....	5	Troubleshooting	21
Basic connections	6	Troubleshooting.....	21
Preparations	6	Specifications	24
Connecting cables	6	Index	24
Connecting the audio equipment	6		
Connecting the speakers	7		
Connecting the speakers cables.....	7		
Speaker connections	8		
Bi-wiring connection	8		
Connecting players	9		
Connecting recorders	10		
Connecting the power cord	10		
Basic operation	11		
Before use	11		
Turning the power on	11		
Turning the power standby.....	11		
Turning the power off.....	11		
Starting playback	11		
Adjusting the levels	12		
Adjusting the tone	12		
Muting the sound	13		
Using headphone set	13		
Switching the illumination lamp setting	13		

Accessories

Check that the following parts are supplied with the product.

- ① Owner's manual..... 1
- ② Power cord..... 1
- ③ Remote control (RC001PMSA) 1
- ④ R03/AAA batteries 2
- ⑤ Warranty card (for USA) 1
- ⑥ Warranty card (for CANADA) 1

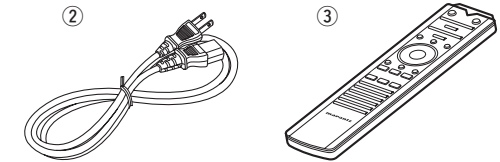

About this manual

❑ Operation buttons

The operations described in this manual are based mainly on remote control operation.

❑ Symbols



This symbol indicates a reference page on which related information is described.



This symbol indicates a supplementary information and tips for operations.

NOTE

This symbol indicates points to remember operations or function limitations.

❑ Illustrations

Note that the illustrations in these instructions are for explanation purposes and may differ from the actual unit.

Cautions on handling

• Before turning the power on

Check once again that all connections are correct and that there are no problems with the connection cables.

- Power is supplied to some of the circuitry even when the unit is set to the standby mode. When going on vacation or leaving home for long periods of time, be sure to unplug the power cord from the power outlet.

• About condensation

If there is a major difference in temperature between the inside of the unit and the surroundings, condensation (dew) may form on the operating parts inside the unit, causing the unit not to operate properly.

If this happens, let the unit sit for an hour or two with the power turned off and wait until there is little difference in temperature before using the unit.

• Cautions on using mobile phones

Using a mobile phone near this unit may result in noise. If that occurs, move the mobile phone away from this unit when it is in use.

• Moving the unit

Turn off the power and unplug the power cord from the power outlet. Next, disconnect the connection cables to other system units before moving the unit.

• About care

- Wipe the cabinet and control panel clean with a soft cloth.
- Follow the instructions when using a chemical cleaner.
- Benzene, paint thinner or other organic solvents as well as insecticide may cause material changes and discoloration if brought into contact with the unit, and should therefore not be used.

About the remote control

The supplied remote control can be used to control marantz Integrated Amplifier and marantz Super Audio CD player.

- The remote control may not operate some products.

Inserting the batteries

- ① Remove the rear lid in the direction of the arrow and remove it.

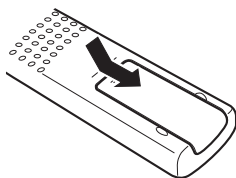

- ② Load the two batteries properly as indicated by the marks in the battery compartment.

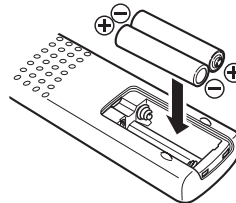

- ③ Put the rear cover back on.

NOTE

- Insert the specified batteries in the remote control unit.
- Replace the batteries with new ones if the set does not operate even when the remote control unit is operated close to the unit. (The supplied batteries are only for verifying operation. Replace them with new batteries at an early date.)
- When inserting the batteries, be sure to do so in the proper direction, following the ⊕ and ⊖ marks in the battery compartment.
- To prevent damage or leakage of battery fluid:
 - Do not use a new battery together with an old one.
 - Do not use two different types of batteries.
 - Do not attempt to charge dry batteries.
 - Do not short-circuit, disassemble, heat or dispose of batteries in flames.
 - Do not keep the battery in a place exposed to direct sunlight or in places with extremely high temperatures, such as near a heater.
- If the battery fluid should leak, carefully wipe the fluid off the inside of the battery compartment and insert new batteries.
- Remove the batteries from the remote control unit if it will not be in use for long periods.
- Used batteries should be disposed of in accordance with the local regulations regarding battery disposal.
- The remote control unit may function improperly if rechargeable batteries are used.

Operating range of the remote control unit

Point the remote control unit at the remote sensor when operating it.

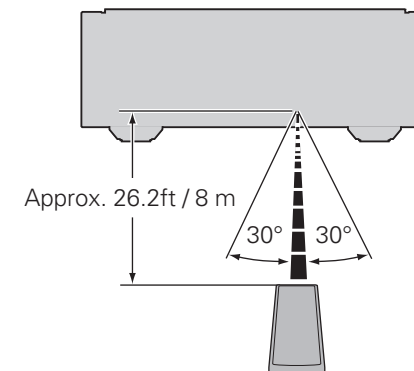

NOTE

- The set may function improperly or the remote control unit may not operate if the remote control sensor is exposed to direct sunlight, strong artificial light from an inverter type fluorescent lamp or infrared light.
- When using 3D video devices that transmit radio communication signals (such as infrared signals etc) between the various units (such as the monitor, 3D glasses, 3D transmitter unit etc), the remote control unit may not operate due to interference from those radio communication signals. If this occurs, adjust the direction and distance of the 3D communication for each unit, and check that the remote control unit operation is not affected by these signals.

Features

HDAM®SA3 Module

This unit includes the HDAM®SA3 which had been developed for high-end models. The HDAM®SA3 is incorporated into many components, such as the current feedback phono equalizer, balance buffer, and input buffer.

Constant Current Feedback Phono Equalizer

This unit incorporates the constant current feedback phono equalizer which had been developed for high-end models. This equalizer, developed by marantz, has the advantages of both NF-type and CR-type phono equalizers, and it supports both MM and MC cartridges.

Current Feedback Balance Buffer Amplifier

The Current Feedback Balance Buffer Amplifier, which incorporates the HDAM®SA3 amp module, is provided with this unit, in order to faithfully convey signals from Super Audio CD players and D/A converters that have high-quality balanced output.

Dedicated Input Buffers for All Line Input Jacks

Each CD, LINE 1, LINE 2, RECORDER 1, and RECORDER 2 input jack has its own input buffer amplifier that incorporates an HDAM®SA3. These amplifiers' arrangement are circuit designed close to the respective jacks. Therefore, each input signals are faithfully conveyed without interference between them.

Linear Control Volume

The control knob had adopted the high-end model design concept. For better S/N ratio, the MAS6116 from Micro Analog Systems and the HDAM®SA3 have been combined, which enables smooth adjustment in the range of 0 to -100 dB in units of ± 0.5 dB.

Tone Control Amplifier

The electronic tone control amplifier is provided for adjustment of bass (low frequency) and treble (high frequency) sound in units of 2 dB in the range of -8 to +8 dB.

Dual-Amplifier Structure

Amplifier of this unit has dual structure, voltage amplifier and power buffer, adopting high-end model design concept. This dual structure enables the power buffer amplifier to drive the speakers powerfully, preventing influence from the back electromagnetic force from the speakers. The voltage amplifier drives the power buffer with superlow distortion.

New-Designed Current Feedback Power Amplifier

To minimize noise of power amplifier, circuit design with lower impedance is incorporated. This enables the user to obtain natural acoustics.

F.C.B.S.

A Floating Control Bus System (F.C.B.S.) enables the user to connect up to four PM-11S3 units, making a diversity of applications possible with complete bi-amp and multichannel connections. Moreover, a ground loop is not formed among multiple PM-11S3 units connected; therefore, sound quality is not adversely affected.

BI-AMP Mode

Complete bi-amp connection proposed by marantz enables a level of reproduction of the acoustic field never before achieved. Synchronized operation of two PM-11S3 units is made possible by F.C.B.S. (Floating Control Bus System) connection, with each PM-11S3 in Bi-Amp mode working as a monaural integrated amplifier.

Power Amplifier Direct In Mode

In this mode, this unit works as a power amplifier. This mode will be useful in home theater systems.

Display

This unit adopts an LCD (Liquid Crystal Display) to display the input source and volume level. Compared with other types of display panels, an LCD requires less drive power and generates less radiation noise, which minimizes any adverse effect on sound quality.

Part names and functions

For buttons not explained here, see the page indicated in parentheses ().

Front panel

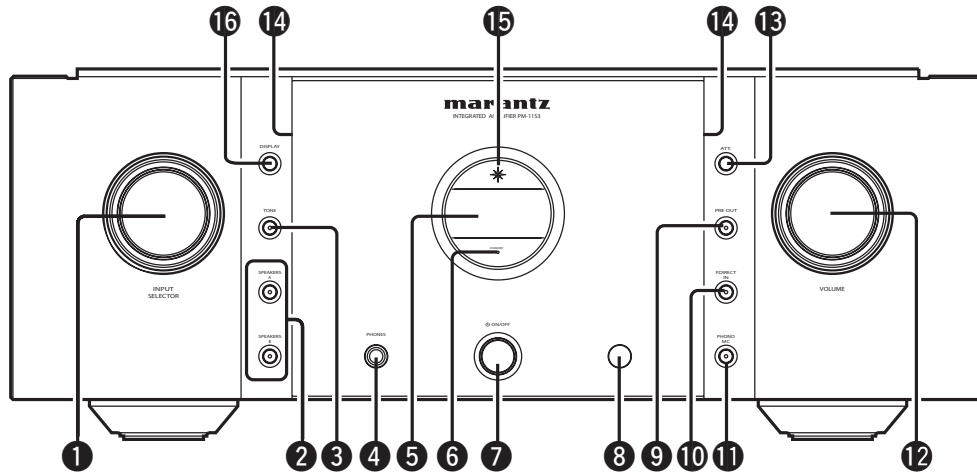

- ① INPUT SELECTOR knob (11)
- ② Speaker output switch button (SPEAKERS A, SPEAKERS B) (11)
- ③ TONE button (12)
- ④ Headphone jack (PHONES) (13)
- ⑤ Display
- ⑥ Standby status indicator
Indicates the status of the unit's as follows:
• Power "ON" Off
• Standby Red
• Power "OFF" Off
- ⑦ Power switch (ON/OFF) (11)
- ⑧ Remote control sensor (2)
- ⑨ PRE OUT switch button (19)
- ⑩ Power amplifier direct mode switch button (P.DIRECT IN) (19)
- ⑪ Phono equalizer switch button (PHONO MC) (9)
- ⑫ VOLUME knob (11)
- ⑬ Attenuator button (ATT.) (13)
- ⑭ Illumination lamp (13)
- ⑮ Power indicator
Indicates the status of the unit's as follows:
• Power "ON" Blue
• Standby Off
• Power "OFF" Off
- ⑯ DISPLAY button (13)

Rear panel

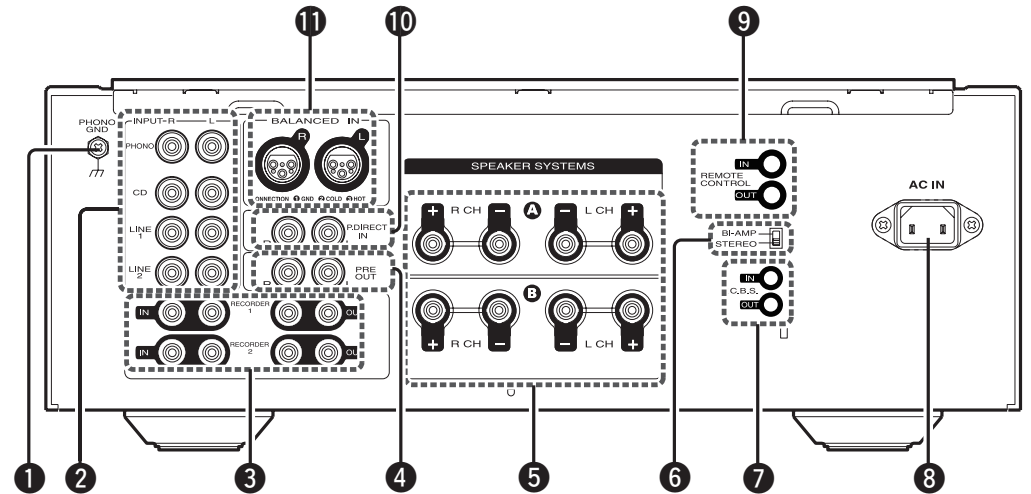

- ① PHONO GND (ground) terminal (9)
- ② Input terminals (INPUT) (9)
- ③ Input/output terminals (Recordings) (RECORDER1, RECORDER2) (10)
- ④ PRE OUT terminals (19)
- ⑤ Speaker system terminals (SPEAKER SYSTEMS) (7, 8)
- ⑥ Amplifier mode switch (16)
- ⑦ F.C.B.S. terminals (14)
- ⑧ AC inlet (AC IN) (10)
- ⑨ REMOTE CONTROL terminals (20)
- ⑩ Power amplifier direct terminals (P. DIRECT IN) (19)
- ⑪ Balanced input terminals (9)

NOTE

This terminal is not a safety ground.

Remote control

Buttons for amplifier

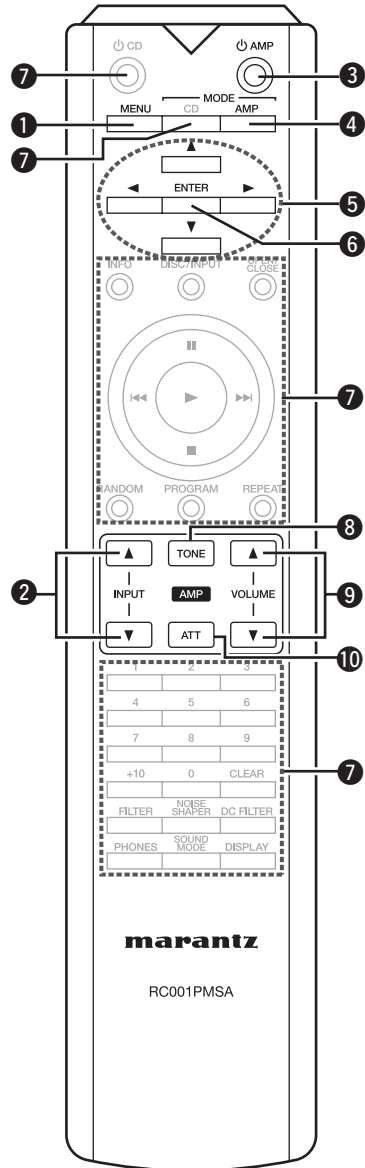

- 1 MENU button (12)
- 2 Input selector buttons (INPUT) (11)
- 3 Amplifier power button (AMP) (11)
- 4 Remote control mode switch button (MODE AMP) (12)
- 5 Cursor buttons (▲▼◀▶) (12)
- 6 ENTER button (12)
- 7 Buttons for Super Audio CD player
- 8 TONE switch button (12)
- 9 VOLUME buttons (▲▼) (11)
- 10 Attenuator button (ATT) (13)



- The supplied remote control can be used to control marantz Integrated Amplifier and marantz Super Audio CD player.
- When using this remote control, also refer to the operating instructions of the other devices.

NOTE

The remote control may not operate some products.

Buttons for Super Audio CD player

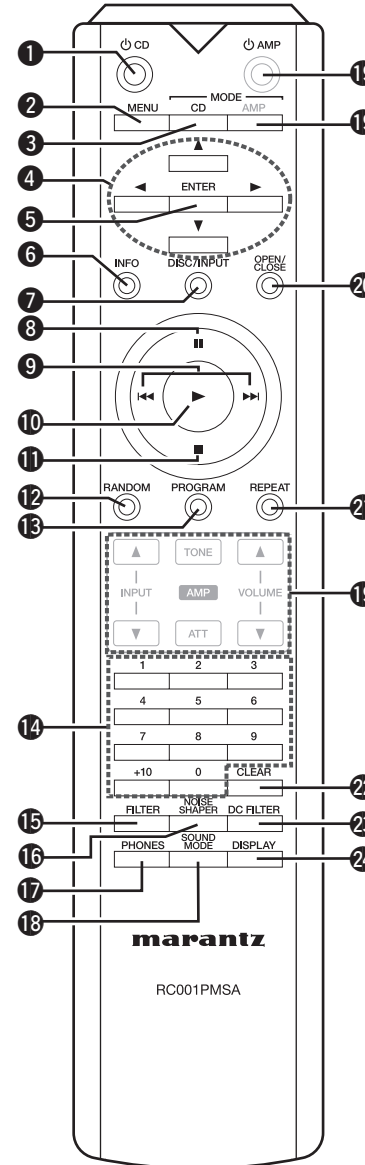

- 1 Super Audio CD player power button (CD)
- 2 MENU button
- 3 Remote control mode switch button (MODE CD)
- 4 Cursor buttons (▲▼◀▶)
- 5 ENTER button
- 6 Information display switch button (INFO)
- 7 Input selection button (DISC/INPUT)
- 8 Pause button (II)
- 9 Skip buttons (I◀◀, ▶▶I)
- 10 Playback button (▶)
- 11 Stop button (■)
- 12 RANDOM button
- 13 PROGRAM button
- 14 Numeric buttons (0 – 9, +10)
- 15 FILTER button
- 16 NOISE SHAPER button
- 17 PHONES button
- 18 SOUND MODE button
- 19 Buttons for amplifier
- 20 Disc tray OPEN/CLOSE button
- 21 REPEAT button
- 22 CLEAR button
- 23 DC FILTER button
- 24 DISPLAY button

Basic connections

NOTE

- Do not plug in the power cord until all connections have been completed.
- When making connections, also refer to the operating instructions of the other components.
- Be sure to connect the left and right channels properly (left with left, right with right).
- Do not bundle power cords with connection cables. Doing so can result in humming or noise.
- Do not turn up the volume without a turntable connected to the PHONO input terminals. Doing so will cause humming or noise.

Preparations

Connecting cables

Select the cables according to the equipment being connected.

Audio cables

Analog connections (UNBALANCED)



Pin-plug cable (sold separately)

Analog connections (BALANCED)

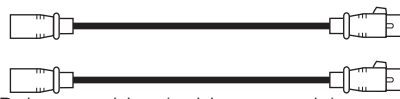

Balance cables (sold separately)

Speaker connections



Speaker cables (sold separately)

Connecting the audio equipment

Cautions on playing SA sources:

When regular speakers not compatible with SA sources (DVD Audio discs, Super Audio CDs and other sources, including treble components above the audible range), set the properties of the player (DVD Audio player, Super Audio CD player, etc.) for use with regular speakers (or amplifiers). The speakers may be damaged if the volume is set too high when playing SA sources. For instructions on player settings, refer to the operating instructions included with the player.

Connecting the speakers

Connecting the speakers cables

Carefully check the left (L) and right (R) channels and + (red) and - (white) polarities on the speakers being connected to the unit, and be sure to connect the channels and polarities correctly.

1 Peel off about 0.03 ft / 10 mm of sheathing from the tip of the speaker cable, then either twist the core wire tightly or apply solder to it.



2 Turn the speaker terminal counterclockwise to loosen it.

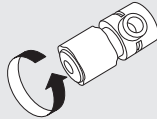

3 Insert the speaker cable's core wire to all the way into the speaker terminal.

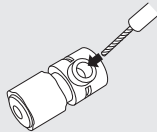

4 Turn the speaker terminal clockwise to tighten it.

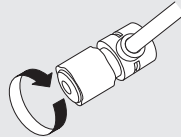

Spade lug connector

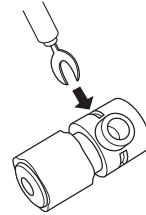

When using a banana plug

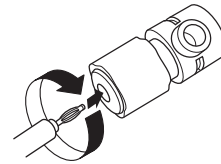

Tighten the speaker terminal firmly before inserting the banana plug.

NOTE

- Connect the speaker cables so they do not stick out of the speaker terminals. The protection circuit may be activated if the wires touch the rear panel or if the + and - sides touch each other (☞ page 21 "Protection Circuit").
- Never touch the speaker terminals while the power supply is connected. Doing so could result in electric shock.

Speaker impedance

Use speakers with impedances within the ranges shown below to suit how they are used.

Speakers used	Impedance
A	4 – 16 Ω
B	4 – 16 Ω
A and B	8 – 16 Ω
Bi-wiring Connection	8 – 16 Ω

Protection circuit

The protection circuit is be activated in the following situations:

- If the speaker cable wire touches the rear panel or screws or if the speaker cable wire touches the speaker cable's + and - sides are touching
- If the surrounding temperature is extremely high
- If the inside of the amplifier gets hot to extended use at a high output

If this happens, unplug the power cord, then check the connections of the speaker cables and input cables.

If the unit becomes very hot, wait for it to cool off and improve the ventilation around it. After doing this, plug the power cord back in.

If the protection circuit is activated even though there are no problems with the ventilation around the unit or in connections, the unit may be damaged. Turn off the power and then contact a marantz service center.

Speaker connections

- The same signal is output from the SPEAKER A and B terminals.
- When only one set of speakers is to be connected, use either the SPEAKER A or B terminals.

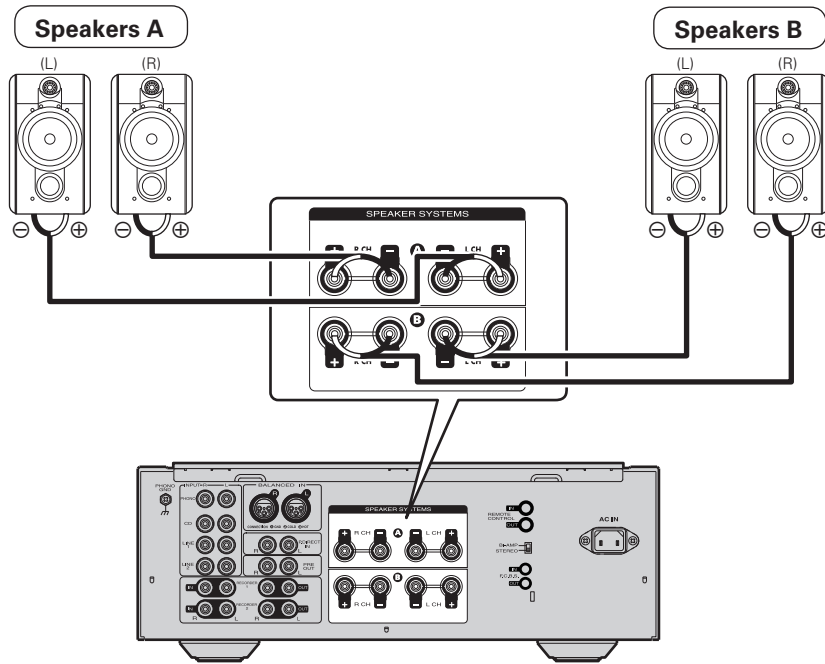

Bi-wiring connection

- When bi-wiring with bi-wireable speakers, connect the mid and high range terminals to SYSTEM (A) (or SYSTEM (B)), the low range terminals to SYSTEM (B) (or SYSTEM (A)).
- This enables playback with minimal interference between the high-range speaker unit and the low-range speaker unit.

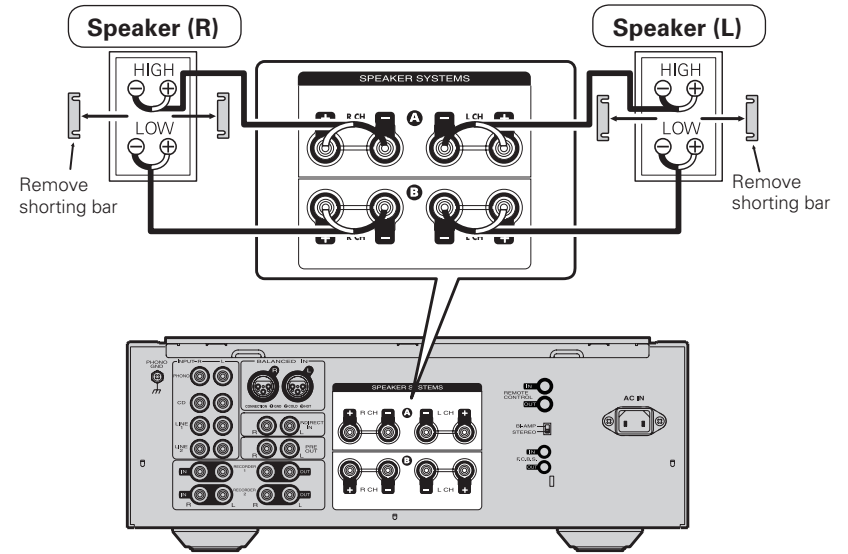

Connecting players

Set phono equalizer switch button by the type of your cartridge to be used MM or MC.

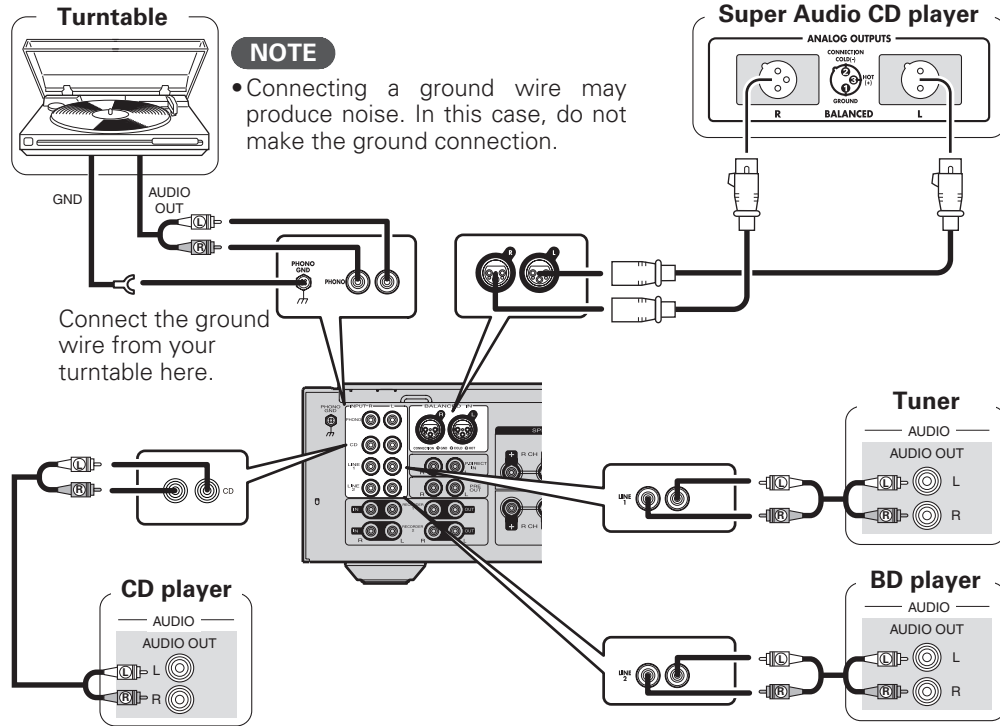

BALANCED Jacks

The BALANCED jacks on this unit are equipped with XLR connectors that are widely used on professional equipment. Their features are listed below.

- The 3 pin construction enables the musical signal to be transmitted as a balanced signal, with little effect from external noise
- The detachable locking mechanism minimizes connector play and enhances connection reliability.

The XLR connector for professional use is internally wired in either of the following two systems.

- USA system (② PIN=COLD ③ PIN=HOT)

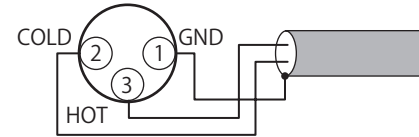

- European system (② PIN=HOT ③ PIN=COLD)

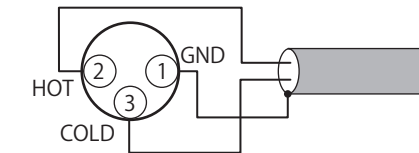

If a product that employs the European system is connected with this unit via a balanced cable, the reproduced signal may be phase-inverted.

To correct the inversion, connect the one side XLR connector reversing the ② PIN and ③ PIN.

Connecting recorders

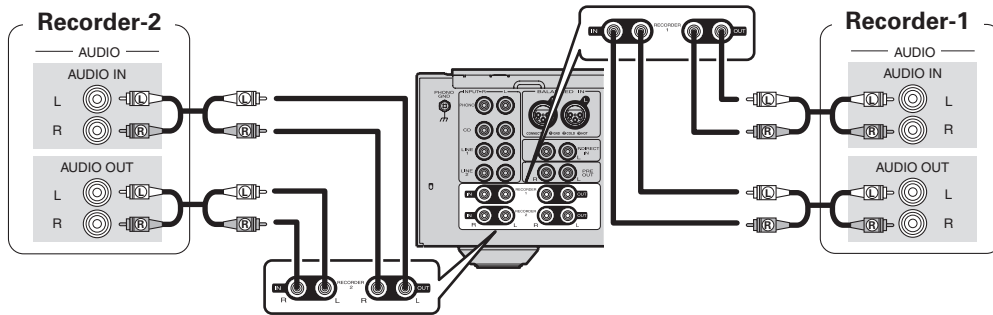

Connecting the power cord

Do not plug in the power cord until all connections have been completed.

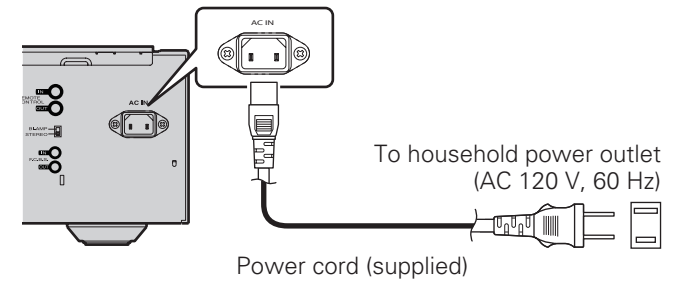

NOTE

Insert the plugs securely. Loose connections will result in the generation of noise.

Basic operation

Before use

Turning the power on

Press **ON/OFF** on the unit.

- Power is turned on.
- The power indicator lights in blue.
- The unit will be ready to start playback after several seconds.

Turning the power standby

Press **AMP**.

- The power is set to the standby mode.
- The Standby status indicator lights in red.

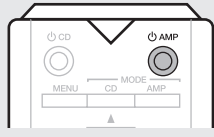

- Press **AMP** to turn on power from standby mode.
- You can also turn on power by using either **INPUT SELECTOR** on this unit from standby mode.

NOTE

Power continues to be supplied to some of the circuitry even when the power is in the standby mode. When leaving home for long periods of time or when going on vacation, either press **ON/OFF** to turn off the power, or unplug the power cord from the power outlet.

Turning the power off

Press **ON/OFF** on the unit.

- Power is turned off.
- All indicators will turn off.

Starting playback

1 Press **SPEAKERS A/SPEAKERS B** on the unit to select the speaker system to be used for playback.

2 Use **INPUT SELECTOR** on the unit or **INPUT ▲▼** on the remote control to select the source.

- The input source changes as follows with each press of the button:

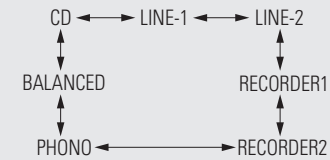

3 Start playing back the source.

4 Adjust the **VOLUME ▲▼** on the unit or remote control to the desired level.

Adjusting the levels

Left and right channel balance

The volume level of the left and right channels can be trimmed in 0.5 dB steps across a 0.0 – 9.0 dB range. When the unit is shipped from the factory, the volume level is set to 0.0 dB (maximum).

1 Press MENU.

The unit enters the level adjustment mode.

- The left channel level value flashes.

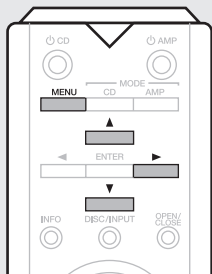

2 Press ▲▼ to adjust the left channel level.



3 Press ►.

The adjustment mode selects the right channel.

- The right channel level value flashes.



4 Press ▲▼ to adjust the right channel level.

5 Press MENU.

The unit exits the adjustment mode.

- If you have connected a "SLAVE" device using the F.C.B.S. connection (page 14), proceed to the slave setting.

Adjusting the tone

Low frequency range

The low frequency range can be trimmed in 2 dB steps across a –8 – +8 dB range. When the unit is shipped from the factory, the level is set to 0.0 dB. Before making this adjustment, press **TONE** on the unit or the remote control to set the tone control to on.

1 Press MENU.

The unit enters the level adjustment mode.

2 Press ENTER.

The adjustment mode selects the low frequency range.

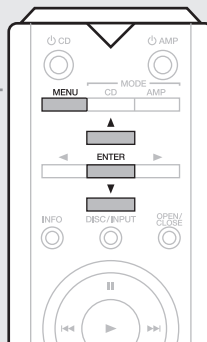

3 Press ▲▼ to adjust the level.



- If not operated for 15 seconds, the current setting is saved and the display returns to normal.

High frequency range

The high frequency range can be trimmed in 2 dB steps across a –8 – +8 dB range. When the unit is shipped from the factory, the level is set to 0.0 dB. Before making this adjustment, press **TONE** on the unit or the remote control to set the tone control to on.

1 Press MENU.

The unit enters the level adjustment mode.

2 Press ENTER twice.

The adjustment mode selects the high frequency range.

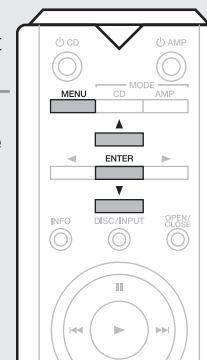

3 Press ▲▼ to adjust the level.



- If not operated for 15 seconds, the current setting is saved and the display returns to normal.

NOTE

Before making the adjustment for level and tone, press **MODE/AMP** to set its control mode to amplifier.

Muting the sound

Sound can be muted temporarily.

Press **ATT**.

"ATT" appears on the display and the sound is muted.



- To restore the sound, press the button again.

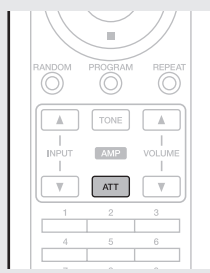

□ How to Set Attenuation Level

- Attenuation level can only be set using **ATT** on the unit.
- The attenuation level can be set at -20 dB, -40 dB, or $-\infty$.
- The factory default setting is -20 dB.

1 Press and hold **ATT** on the unit for 2 seconds or longer.

The attenuation level will appear on the display.



2 Press **ATT** on the unit.

- Each time the button is pressed, the attenuation level changes as follows:

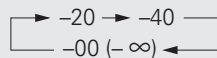

- If not operated for 2 seconds, the current setting is saved and the display returns to normal.

Using headphone set

Plug headphones into **PHONES** jack.

- When using headphones, turn off the speaker output using **SPEAKERS A/SPEAKERS B**.
- To prevent hearing loss, do not raise the volume level excessively when using headphones.

Switching the illumination lamp setting

The illumination lamps on the both sides of the unit main panel can be turned on or off.

Press and hold **DISPLAY** on the unit for 2 seconds or longer.

The on/off setting changes as follows with each press of the button.

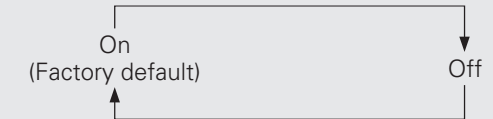

Advanced connections

F.C.B.S. connection

The marantz F.C.B.S. (Floating Control Bus System) is the high quality sound system for link control between multiple PM-11S3 units (up to 4 units). Each unit is controlled via its ID number registered beforehand.

The ID numbers need to be set to an operating unit (master) and a subordinate unit (slave) receiving the command from the master. For slave units, register ID numbers in the order of command reception from the master.

Once registered the ID numbers, the units will enable link control operations such as input selection, volume control, on/off selection of muting, display, tone control, etc.

Furthermore, F.C.B.S. connection of multiple units has the feature that switches this unit's output from stereo to monaural so that the unit can work as a monaural output amplifier. Follow the respective instructions to make the necessary settings.

Preparation for F.C.B.S. connection

□ Making the F.C.B.S. connection

To use multiple PM-11S3 units, make this connection in addition to audio connection. For details on each connection feature, refer to the respective instructions.

Prepare the correct number of portable audio connection cables for the number of units to be connected. Either of the following types of connection cables are adequate.

- Monaural mini plug ←→ monaural mini plug connecting cable

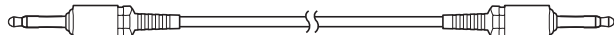

- Stereo mini plug ←→ stereo mini plug connecting cable

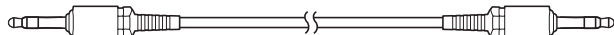

NOTE

Do not use connecting cables that contain resistance.

□ Connection example

In the connection of the following example, an unit with ID number 1 acts as a master amplifier to control all the other slave units with ID numbers 2 to 4.

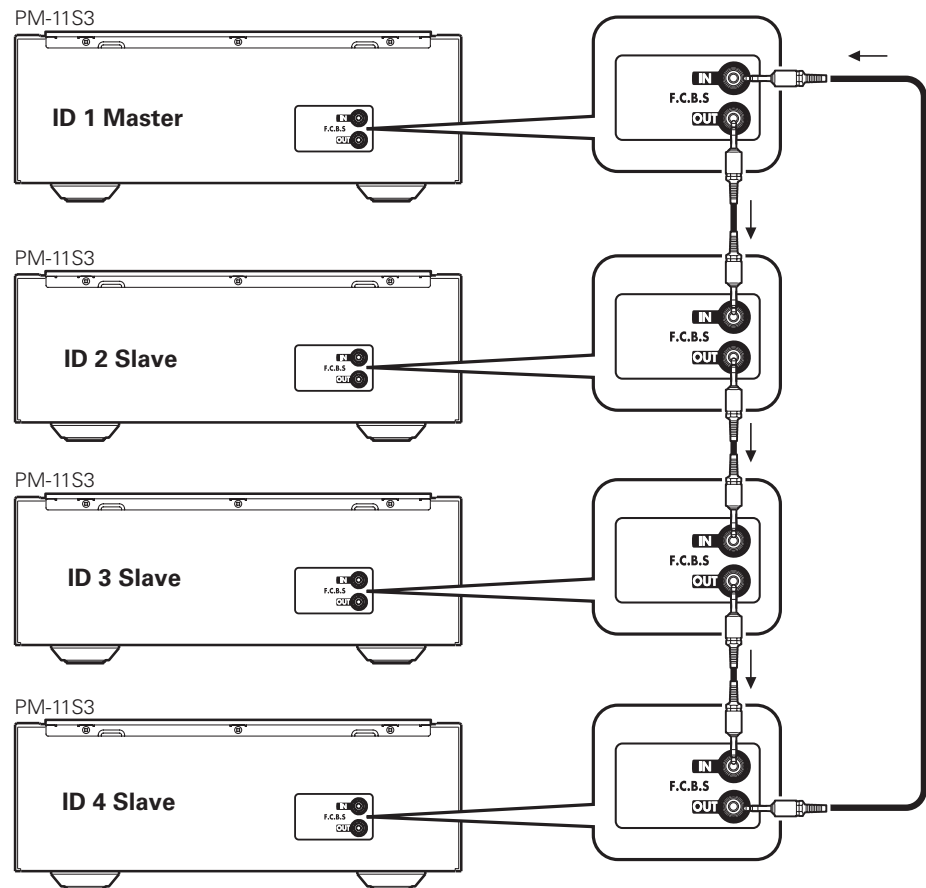

NOTE

- The PM-11S3 F.C.B.S. function is only valid between the same PM-11S3 models. This function may not operate correctly if other marantz models (PM-11S2, etc.) are connected.
- To turn the power of multiple F.C.B.S.-connected units ON/OFF, switch the power ON in order of lowest to highest ID number, and switch the power OFF in order of highest to lowest ID number.

□ How to set ID number for F.C.B.S.

When the unit is turned on, the display shows the ID number for three seconds.



For a master unit, ID number 1 needs to be assigned.

For a slave unit, set any of ID numbers 2 to 4.

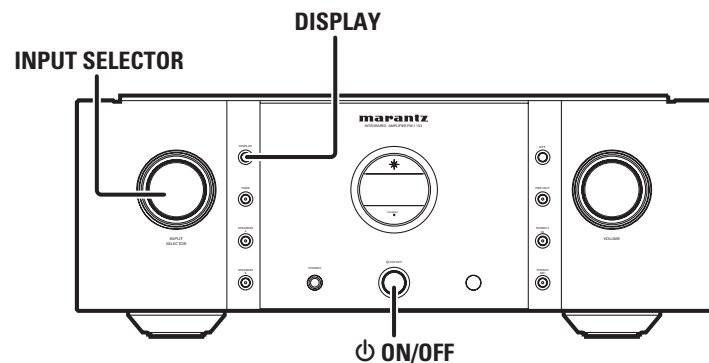

1 While holding **DISPLAY** on the unit, press **ON/OFF**.



2 Turn **INPUT SELECTOR** on the unit to select an ID number.



3 Turn the unit off.

4 Again turn the unit on.

- The setting is saved.
- The unit registered as a slave shows "SLAVE" on the display.

NOTE

- If using this unit by itself as a stereo amplifier, set the ID number to "0" (Default setting is "0").
- If the ID number is set to a number other than "0", this unit cannot be used for standalone operation.

Stereo complete bi-amp connection

This mode enables the two amplifiers connected to this unit to function as one monaural amplifier. To use this mode, two F.C.B.S. connected PM-11S3 units are required.

To switch the mode, use the amplifier mode switch on the rear panel while the power is off.



The figures below show example displays in the stereo and bi-amp modes.

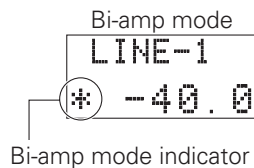
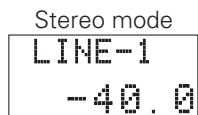

In bi-amp mode, connect to the left channel input jack. The right channel input is disabled.

The same signals are output from the left and right output jacks.

NOTE

- Always turn the power to the unit OFF before changing the operating mode switch setting. Turning the power ON again activates the new setting.
- When in bi-amp mode, the R channel input jacks cannot be used.
- When in bi-amp mode, the signals input into the L channel are output from both channels. Therefore, the same signals are output from the L channel and R channel in RECORDER OUT, PRE OUT, PHONES OUT.
- Speaker systems connected using complete bi-amp connections must support bi-amp connections. Before connecting your speakers, check in the instruction manual that came with the speakers or contact the manufacturer to confirm whether they support bi-amp connection.

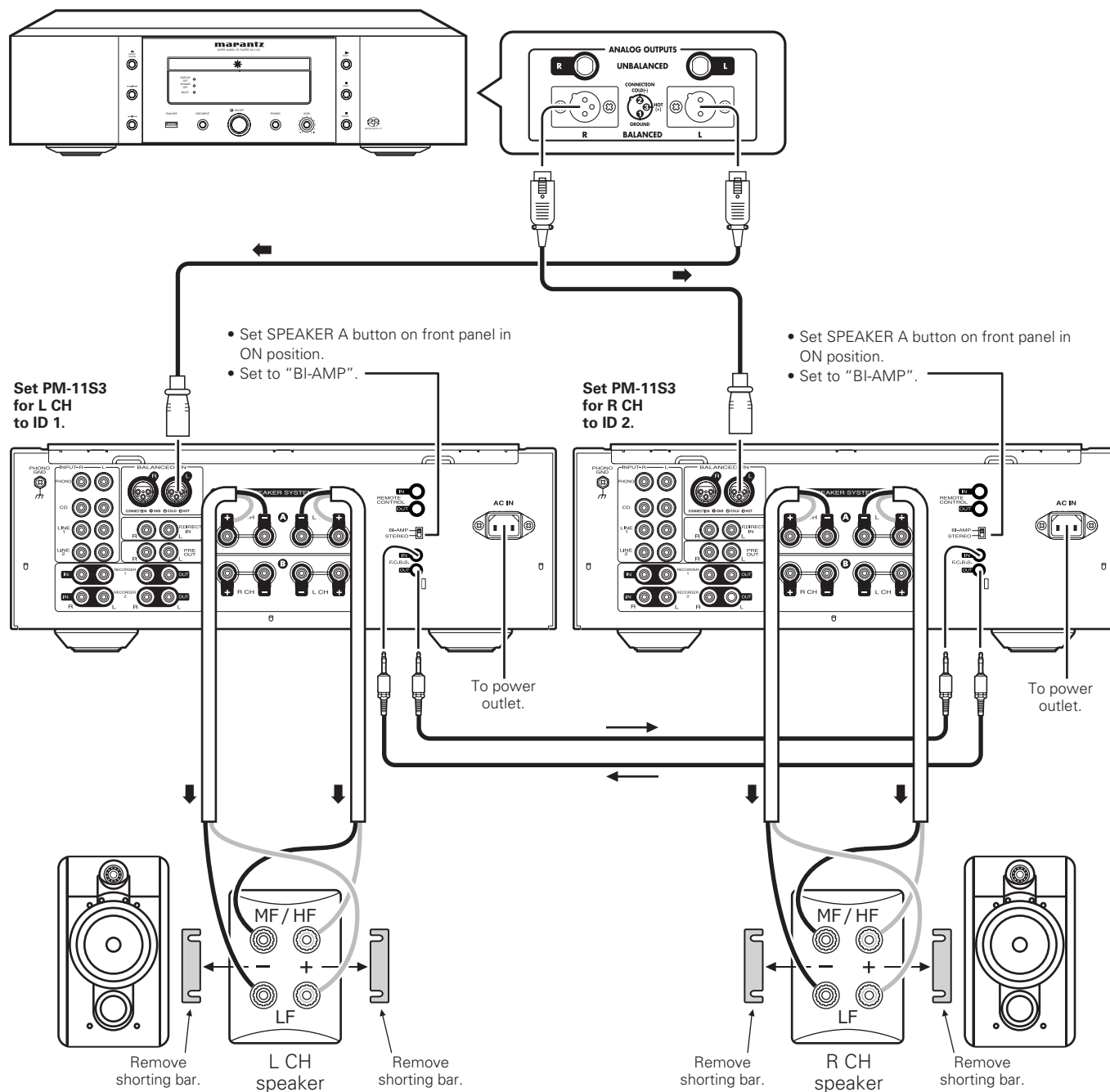

Connection for 5.1 Multi-channel Playback

The three units are connected using F.C.B.S. For the F.C.B.S. connection, prepare 3 audio connection cables, and refer to F.C.B.S. (page 14).

Connect the outputs of players that have 5.1 channel analog outputs to each of the three units.

If using an active subwoofer, see the instruction manual that came with the subwoofer for further instructions.

Set the ID numbers for the three amplifiers as explained in How to set ID number for F.C.B.S. (page 15).

- When the ID 1 unit is operated, ID 2 and ID 3 units will operate in sync.

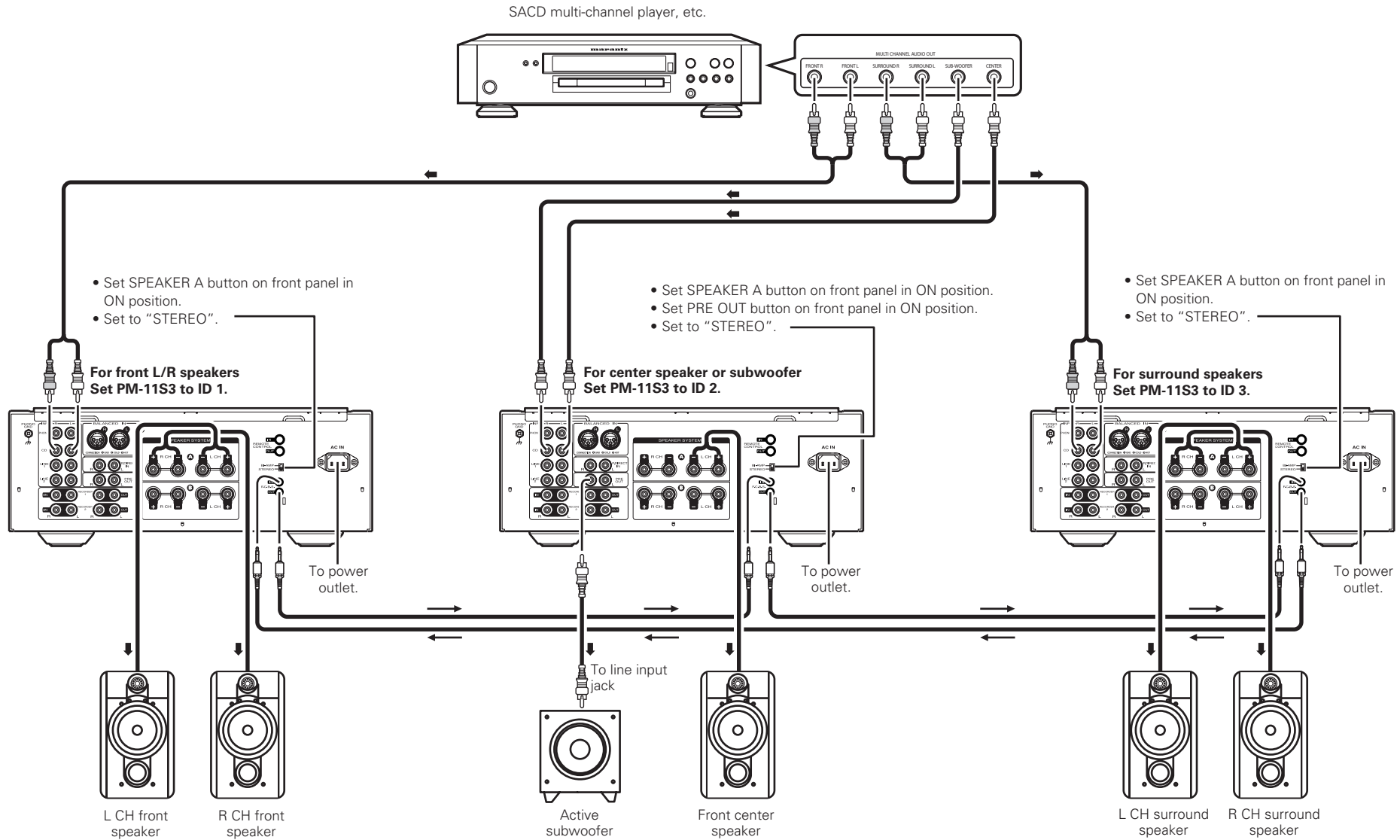

Speaker Positioning for Super Audio Multi-channel Sound

In order to enjoy Super Audio CD multi-channel sound with the best possible acoustics, it is recommended to position speakers as specified in ITU-R BS.775-1 of the International Telecommunication Union (ITU). Super Audio CD multi-channel discs are recorded and mixed so as to achieve the optimum effect with a speaker system laid out as specified in ITU-R BS.775-1.

- With Super Audio CD multi-channel discs, the music signals are basically recorded using 5 channels (3 - 6 channels sometimes), but in some cases, LFE (for subwoofer) is recorded as a sixth channel.
- Each disc indicates how many channels have been recorded on it.
- The basic layout is 3 speakers in the front and 2 in the back since multi-channel discs usually have 5 channels. The 2 front, 1 center and 2 surround (rear) speakers should be set in a circle around the listening point. If using speakers of differing sizes, adjust volume balance from the amplifier.
- The location of the subwoofer in the figure is just for explanatory purposes. It can be located anywhere in the room. For connection and positioning instructions, see the instruction manual that came with the subwoofer.

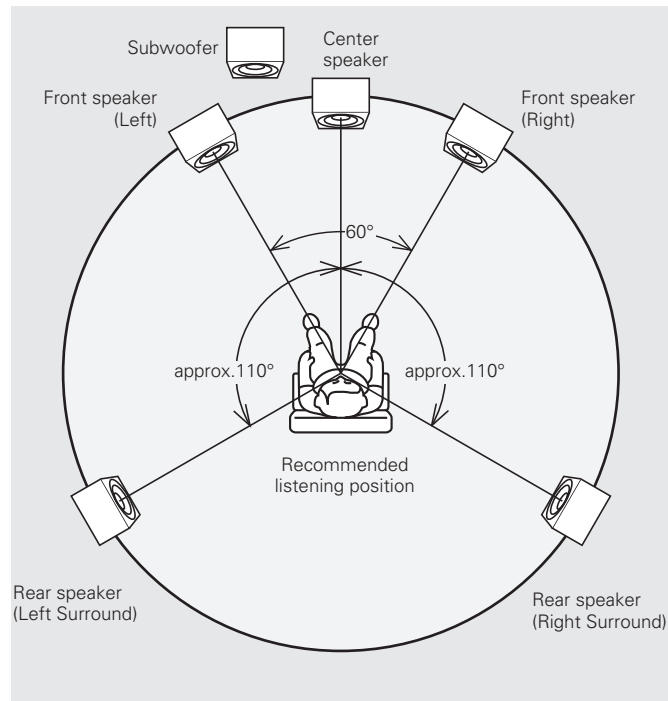

- ITU (International Telecommunication Union)

The ITU is a special organization of the United Nations. It consists of a number of organs, one of which is the Radio Broadcasting Section.

ITU-R BS in the recommendation which consists of standards relating to broadcasting (audio) operations, one of which is the ITU-R BS.775-1 which governs "multi-channel stereo sound systems".

Connecting P.DIRECT IN connectors

If you use a preamplifier, connect it as shown below, and then you can use this unit as a power amplifier.

Press and hold P.DIRECT IN on the unit for 2 seconds or longer.

- The power direct mode setting changes with each press of the button.

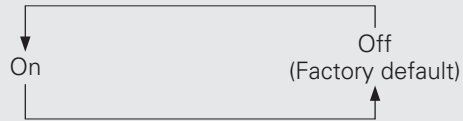

- If the mode is set to on, the display shows "POWER AMP DIRECT".
- On:** Allows the device connected to the Power Amp Direct connector to be played.
- Off:** Allows the program source selected using **INPUT SELECTOR** to be played.

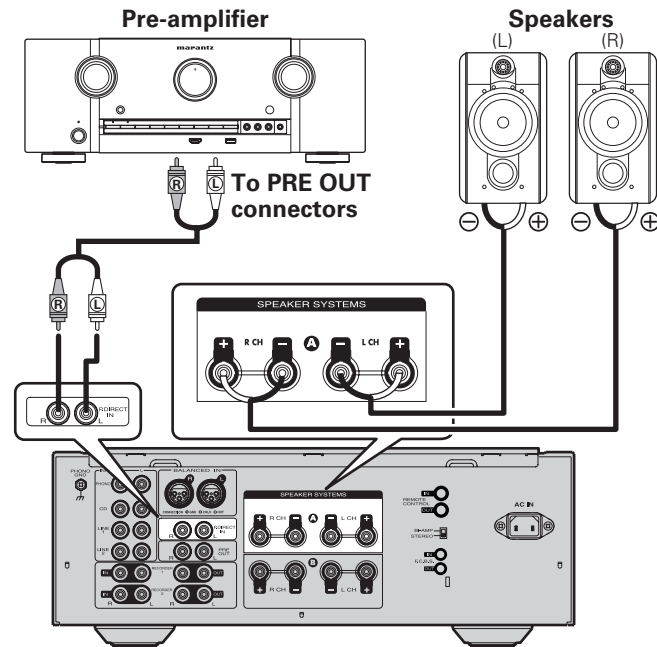

NOTE

- When the POWER AMP DIRECT is "ON", adjustment of the volume, balance and tone on the main unit has no effect. Adjust the volume on the pre-amplifier.
- When the POWER AMP DIRECT is "ON", the main unit outputs at maximum volume. Check the output level on the input device before playing it and adjust the volume accordingly.

Connecting pre out connectors

If you use a power amplifier, connect it as shown below, and then you can use this unit as a preamplifier.

- Press the PRE OUT switch button on this unit to turn on the PRE OUT function.
- For connecting speaker systems, refer to the instruction manual supplied with the power amplifier to be used.

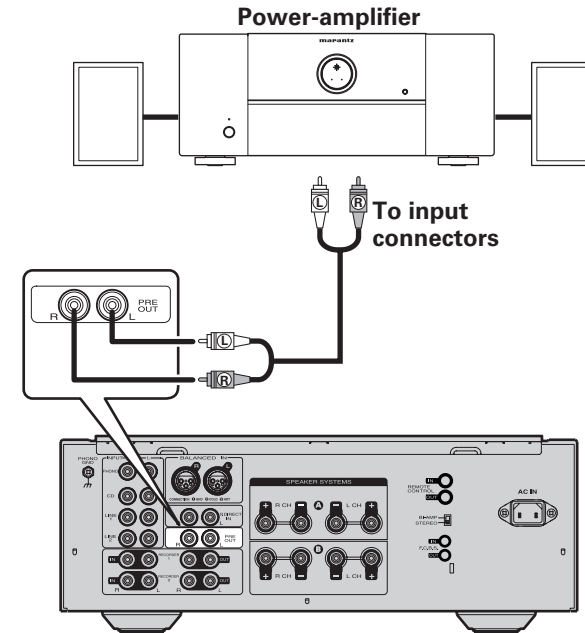

NOTE

The power amp direct function and the pre out function cannot work at the same time.

Connecting the remote control connectors

When you use this unit connected to marantz audio components, it sends control signals to operate each component.

□ Connection

Use the remote connection cable (supplied with a marantz audio component you want to connect) to connect the REMOTE CONTROL OUT terminal of this unit to the REMOTE CONTROL IN terminal of the component to be connected.

□ Setting

Set the remote control switch located on the rear panel of the connected audio component to "EXTERNAL" or "EXT." to use this feature.

- This setting will disable remote sensor reception of the connected audio component.
- To operate the connected audio component, point the remote control at the remote sensor of this unit.
- To use the system control to this unit via the connected device, make the connection following the instructions supplied with the connected device.

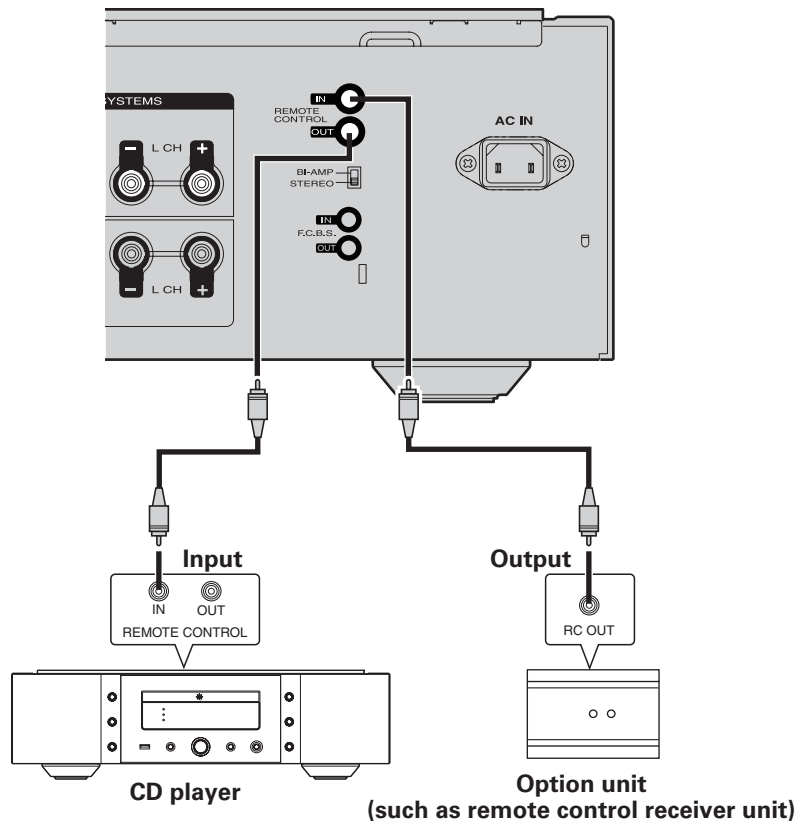

Advanced operations

Setting Auto standby mode

With the Auto standby mode ON, this unit will automatically enter the standby mode after about 30 continuous minutes of no output from the selected input source.

Press and hold TONE on this unit for 5 seconds or longer.

- Auto standby mode is switched between On and Off with each press of the button.

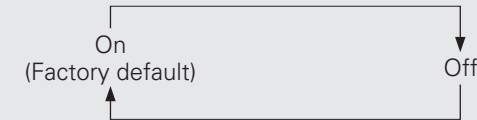

- If the mode is set to off, the display shows "AUTO STBY OFF".



- This unit will automatically enter standby mode after about continuous 30 minutes in the following conditions.
 - No operation performed on the remote control.
 - No operation of this unit.
- The display will show the remaining time for three minutes before the units enters standby mode.
- In F.C.B.S. connection, only the ID 1 master unit activates Auto standby mode. If the ID 1 master unit is operated with no audio input, set the Auto standby mode to OFF.

Explanation terms

MM/MC cartridge select

There are two types—MM (Moving Magnet) and MC (Moving Coil)—of cartridges for turntable.

As the output levels for these two types of cartridges differ, the setting of the phono equalizer that is mounted in this unit must be switched according to the type of cartridge for your turntable. For switching, use the **PHONO MC** button on this unit.

Speaker impedance

This is certain-rated resistance of the speaker set to an alternating current and expressed in ohms.

The smaller the impedance, the greater the output. However, load on the amplifier is increased. Use speakers whose impedance is supported by this unit

Bi-wiring Connection

This method of connecting a speaker by using two speaker cables enables separate transmission of treble and bass signals.

This enables playback with minimal interference between the high-range speaker unit and the low-range speaker unit.

Protection Circuit

This is a function to prevent damage to components within the power supply when an abnormality such as an overload or excess voltage occurs for any reason.

In this unit, the power indicator blinks and the unit enters standby mode when an abnormality occurs.

Troubleshooting

Troubleshooting

□ About the protection circuit

This unit is equipped with a protection circuit to protect the amplifier circuits and speaker system from damage.

If the protection circuit is activated, the sound is instantly muted.

In this case, the message “PROTECT” flashes on the display panel, and the STANDBY indicator also flashes.

To deactivate the protection circuit, turn the unit off then back on again after about 1 minute or more.

At power on

For about 8 seconds after the power is turned on, the protection circuit is activated, muting the sound to give the amplifier circuits time to stabilize. Once the amplifier circuits stabilize, the protection circuit is released, and audio is enabled.

In the event of overcurrent

The protection circuit is activated if current exceeding a certain level is detected, which can happen if excessive signal flow is input to the amplifier or if the unit is connected to a speaker system of less than 4 Ω impedance. The protection circuit is also activated if a speaker cable shorts.

In such cases, the message “PROTECT” flashes on the display, and the volume is automatically reduced. After approximately 8 seconds, the protection circuit is released. Therefore, the volume needs readjusting to continue normal use.

If the overcurrent continues, the amplifier shuts itself OFF, and the STANDBY indicator flashes.

To deactivate the protection circuit, turn the unit off then back on again after about 1 minute or more.

If excessive ultrabass signals are input

The protection circuit is also activated if ultrabass signals are input. In such a case, the STANDBY indicator flashes, and the volume is automatically reduced. After approximately 8 seconds, the protection circuit is released. Therefore, the volume needs readjusting to continue normal use. If excessive ultrabass signal input continues or if DC voltage is detected owing to trouble with the amplifier, the amplifier shuts itself OFF, and the STANDBY indicator flashes.

To deactivate the protection circuit, turn the unit off then back on again after about 1 minute or more.

If the main-amplifier overheats

The protection circuit is activated if the temperature of the main amplifier section rises above a certain level, which can happen if the amplifier is continuously used with excessive signal flow being input to it. The protection circuit is also activated when the specified operating temperature is exceeded, which can happen if the vents on top of the amplifier are covered or if the amplifier is installed on a cramped audio rack. In such a case, the STANDBY indicator flashes, and the volume is automatically reduced. After approximately 8 seconds, the protection circuit is released. Therefore, the volume needs readjusting to continue normal use.

If the temperature does not sufficiently fall within a certain amount of time after the protection circuit activation, the amplifier shuts itself OFF, and the STANDBY indicator flashes. To deactivate the protection circuit, turn the unit off, let it stand until it cools down, then turn it ON again.

In the event of amplifier trouble

The protection circuit is activated, and the power is automatically shut OFF, if an abnormality is detected in the power circuit. The same happens if the main fuse inside the amplifier blows. In such cases, the STANDBY indicator flashes. Turn the unit off then after several minutes turn it on again. If the display does not light up, and the STANDBY indicator remains flashing after the unit is turned on again, the unit may be in failure.

❑ Error messages

When multiple amplifiers are connected by F.C.B.S., the error messages described in the table below may be displayed on the display. In such a case, ID number setting or remote cable connection may be in failure. Check the ID number or remote cable connection, referring to the table below. For details on ID number setting, see "How to set ID number for F.C.B.S." (page 15).

	Indication	Meaning
1	ERROR 02	Multiple amplifiers take ID No. 2.
2	ERROR 03	Multiple amplifiers take ID No. 3.
3	ERROR 04	Multiple amplifiers take ID No. 4.
→ Assign different ID numbers to the amplifiers.		
4	ERROR 11	The amplifiers with ID Nos. 2-4 cannot communicate with the amplifier with ID No. 1.
→ If the amplifier with ID No. 1 is not on, turn it ON.		
→ Check that the remote cable is properly connected.		
5	ERROR 12	The amplifier with ID No. 1 cannot communicate with the amplifiers with ID Nos. 2-4.
→ If multiple amplifiers take ID No. 1, set ID numbers properly.		
→ If the amplifier with ID No. 1 is connected to the amplifier with ID No. 0, set ID numbers properly.		
→ Check that the remote cable is properly connected.		

❑ Are the connections correct?

❑ Is the unit being operated as described in the owner's manual?

❑ Are the other components operating properly?

If this unit does not operate properly, check the items listed in the table below. If the problem persists there may be a malfunction. In that case, disconnect the power immediately and contact your retail outlet.

Symptom	Cause	Countermeasure	Page
When the power is turned on, the power indicator does not light and no sound is produced.	<ul style="list-style-type: none"> The power cord's plug is not fully plugged in. 	<ul style="list-style-type: none"> Check the cord is securely inserted into the unit's AC inlet and the wall power outlet. 	10
Power switches off suddenly while you are using the unit, the power indicator will flash in red at intervals of approximately 2 seconds.	<ul style="list-style-type: none"> The protection circuit will be activated depending upon the temperature rise in the internal parts of the unit. 	<ul style="list-style-type: none"> Please switch off power at once, and re-apply the power after the body temperature has fallen sufficiently. Please re-install the unit in a place having good ventilation. 	7 2
Power switches off suddenly while you are using the unit, the power indicator will flash red at intervals of approximately 0.5 seconds.	<ul style="list-style-type: none"> A speaker with impedance not supported by this unit is used. The protection circuit has been activated because the core wires of different speaker cables have touched each other or a core wire was slipped out of the terminal and is touching the unit's rear panel. 	<ul style="list-style-type: none"> Please use speakers which have the specified impedance. Unplug the power cord, then after twisting the core wires together tightly again, or effecting termination treatments etc, please reconnect once again. 	7 7
Even applying power, the power display flashes red at intervals of approximately 0.5 seconds.	<ul style="list-style-type: none"> The amplifier circuit in failure. 	<ul style="list-style-type: none"> Switch off the power and please contact the marantz service adviser. 	–
The power indicator lights but no sound is produced.	<ul style="list-style-type: none"> The speaker cables are not fully connected. The device you want to listen to has not been selected. The volume control is set to minimum. The input cable is not fully connected. The speaker output switch is set to OFF. 	<ul style="list-style-type: none"> Connect securely. Insure the correct input is selected. Set to an appropriate level. Connect securely. Set the speaker output switch to ON. 	7 11 11 9 11
Sound is only produced from the left or right speaker (s).	<ul style="list-style-type: none"> The speaker cables are not fully connected. The input cable is not fully connected. The left/right balance is off. 	<ul style="list-style-type: none"> Connect securely. Connect securely. Adjust to a proper balance with the balance control knob. 	7 9 12

Troubleshooting

Symptom	Cause	Countermeasure	Page
The left and right of stereo sound is reversed.	<ul style="list-style-type: none"> The connections of the speakers or input cables are reversed 	<ul style="list-style-type: none"> Check the connections to be sure that left is connected to left, right to right. 	7
Humming sound is heard in the music when playing turntable.	<ul style="list-style-type: none"> The player's ground wire is not connected. 	<ul style="list-style-type: none"> Connect securely. 	9
	<ul style="list-style-type: none"> The cables are not fully connected to the PHONO terminals. 	<ul style="list-style-type: none"> Connect securely. 	9
	<ul style="list-style-type: none"> Influence from a TV or VCR near the player. 	<ul style="list-style-type: none"> Try changing the positions in which the devices are installed. 	–
Howling is produced along with the music if the volume is too high when playing turntable.	<ul style="list-style-type: none"> The player and speakers are too close together. 	<ul style="list-style-type: none"> Install the player and speakers as far from each other as possible. 	–
	<ul style="list-style-type: none"> The vibrations from the speakers are being transmitted to the player through the floor. 	<ul style="list-style-type: none"> Use cushions, etc., to absorb the speakers' vibrations. 	–
When playing turntable, the sound is distorted.	<ul style="list-style-type: none"> The needle pressure is incorrect. 	<ul style="list-style-type: none"> Adjust to a proper needle pressure. 	–
	<ul style="list-style-type: none"> There is dirt on the tip of the needle. 	<ul style="list-style-type: none"> Check the tip of the needle. 	–
	<ul style="list-style-type: none"> The cartridge is defective. 	<ul style="list-style-type: none"> Replace the cartridge. 	–
The remote control does not work.	<ul style="list-style-type: none"> The batteries are exhausted. 	<ul style="list-style-type: none"> Replace the batteries with new ones. 	2
	<ul style="list-style-type: none"> The remote control unit is too far from the unit. 	<ul style="list-style-type: none"> Operate closer to the unit. 	2
	<ul style="list-style-type: none"> There is an obstacle between the unit and the remote control unit. 	<ul style="list-style-type: none"> Remove the obstacle. 	–
	<ul style="list-style-type: none"> Button selection was mistaken. 	<ul style="list-style-type: none"> Confirm the correct button to press. 	–
	<ul style="list-style-type: none"> The batteries are not loaded with correct polarity (⊕, ⊖). 	<ul style="list-style-type: none"> Correct the direction of the batteries according the polarity instruction. 	2

Specifications

• RMS Power output: (20 Hz - 20 kHz 2-channel simultaneously driven)	100 W × 2 (8 Ω) 200 W × 2 (4 Ω)
• Total harmonic distortion: (20 Hz - 20 kHz 2-channel simultaneously driven, 8 Ω)	0.01 %
• Output band width: (8 Ω, 0.05 %)	5 Hz – 45 kHz
• Frequency response: (CD, 1 W, 8 Ω load)	5 Hz – 120 kHz ± 3 dB
• Damping factor: (8 Ω, 20 Hz – 20 kHz)	100
• Input sensitivity/Input impedance	
PHONO (MC):	260 μV / 100 Ω
PHONO (MM):	2.7 mV / 47 kΩ
BALANCED:	480 mV / 40 kΩ
CD/LINE:	240 mV / 20 kΩ
P. DIRECT IN:	1.7 V / 20 kΩ
• Output voltage/Output impedance	
PRE OUT:	1.9 V / 220 Ω
• Maximum allowable PHONO input level (1 kHz)	
MC:	10 mV
MM:	105 mV
• RIAA deviation: (20 Hz–20 kHz)	± 0.5 dB
• S/N (IHF-A, 8 Ω)	
PHONO (MC):	76 dB (0.5 mV Input, 1 W Output)
PHONO (MM):	88 dB (5 mV Input, 1 W Output)
BALANCED:	109 dB (4 V Input, Rated output)
CD/LINE:	108 dB (2 V Input, Rated output)
• Tone control	
BASS (50 Hz):	± 8 dB
TREBLE (20 kHz):	± 8 dB
• Power requirement:	AC 120 V, 60 Hz
• Power consumption (UL60065):	300 W
• Standby power consumption:	0.2 W

For the purpose of improvement, the specifications and design are subject to change without notice.

Index

A

Accessories	1
Adjust the levels (Left and Right)	12
Adjust the tone	12
Adjust the volume	11
Auto standby mode	20

B

Batteries	2
-----------------	---

C

Cable	
Balance cable	6
Pin-plug cable	6
Speaker cable	6
Condensation	2
Connection	
5.1 Multi-channel Playback	17
Bi-wiring	8
Cables	6
Player	9
Power Amp Direct	19
Power cord	10
PRE OUT connectors	19
Recorder	10
Remote control connectors	20
Speaker	8
Stereo complete bi-amp	16

F

F.C.B.S. connection	14
Front panel	4

H

High frequency range	12
----------------------------	----

I

INPUT SELECTOR	11
Inserting the batteries	2

L

Low frequency range	12
---------------------------	----

M

MM/MC cartridge select	21
Muting the sound	13

P

Protection circuit	7, 21
--------------------------	-------

R

Remote control	5
----------------------	---

S

Speaker impedance	7, 21
-------------------------	-------

Dimensions / Dimensions / Dimensions

Unit / Unité / Unidad : inch (mm)

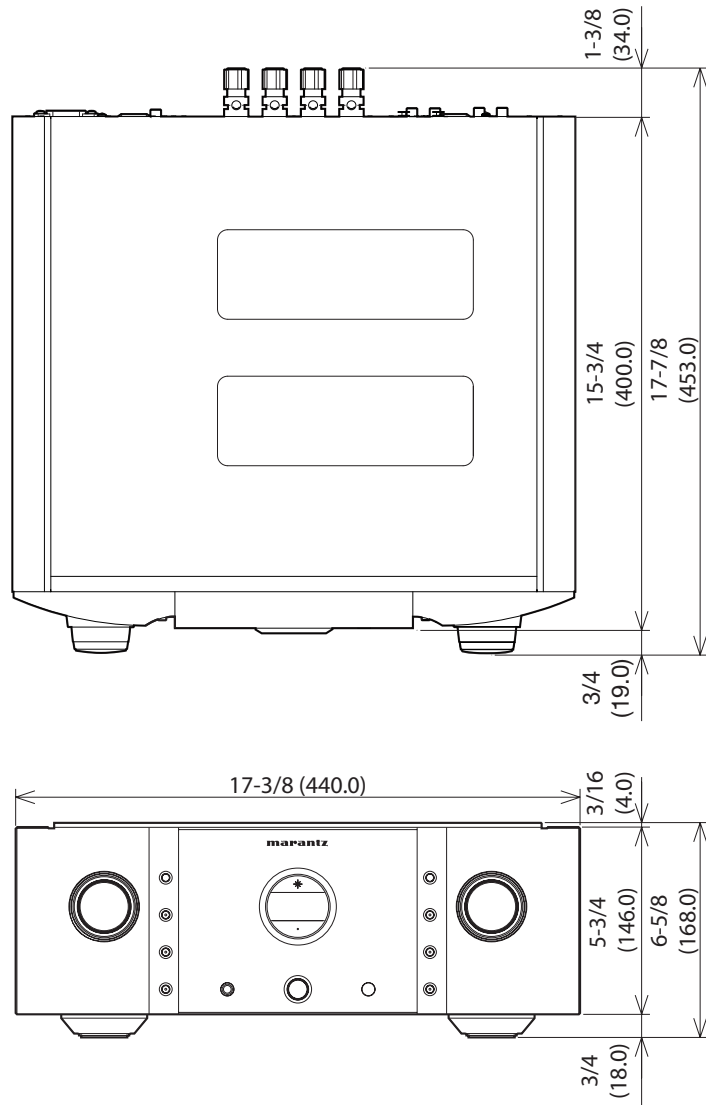

Weight / Poids / Peso : 58 lbs 10 oz (26.6 kg)

www.marantz.com

You can find your nearest authorized distributor or dealer on our website.

marantz[®] is a registered trademark.